

Fensterbänke 1.421 Standard

Detail 1:10 / 10.2023

Fensterbank aus Glasfaserbeton
mit Montagewinkel vor der Montage der Wärmedämmplatten

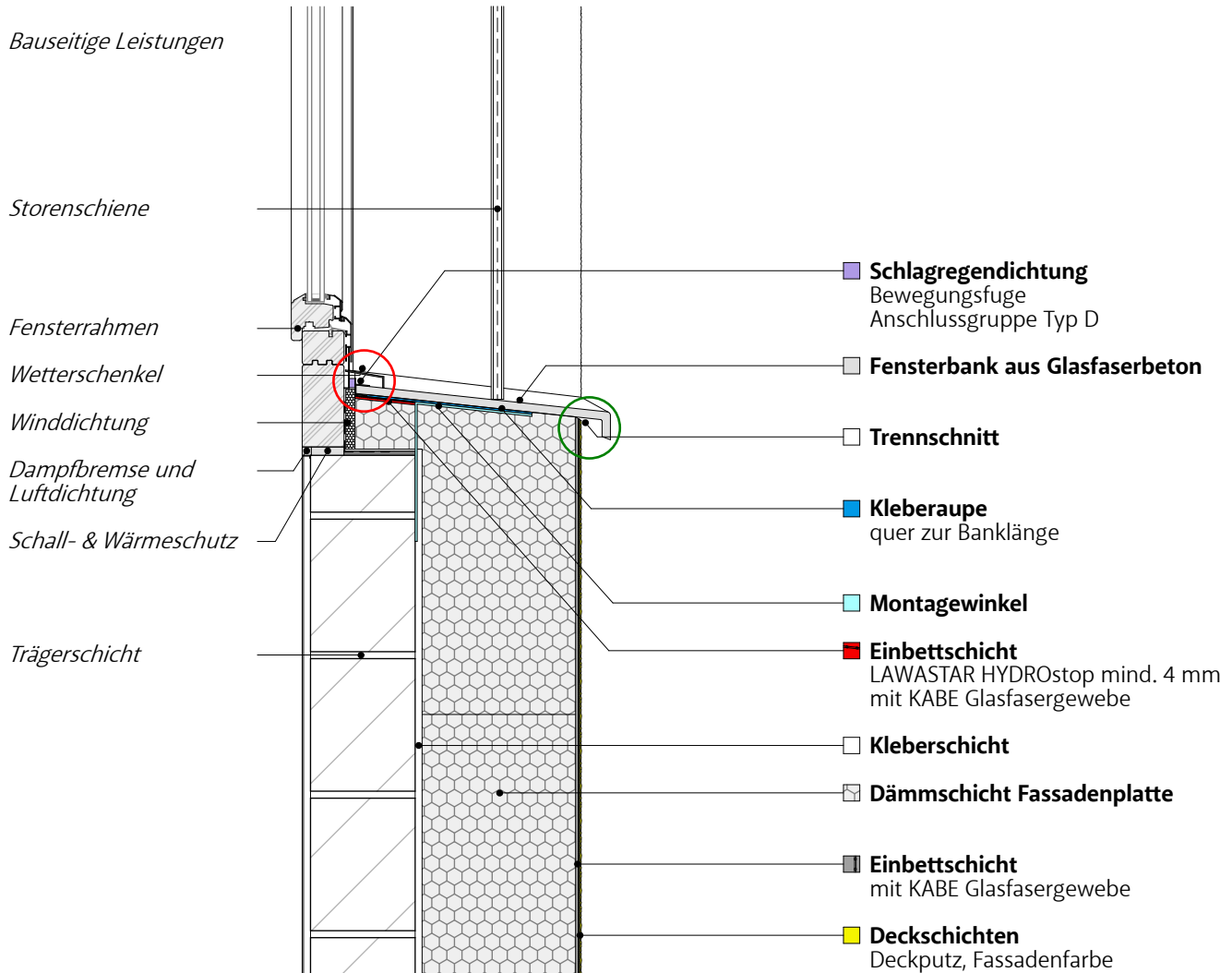

Anschluss

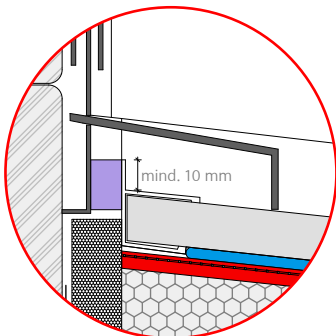

Anschluss

